

Serial No.09/618530; docket 120-183
Andersson et al.
Faxed 2/1/2006

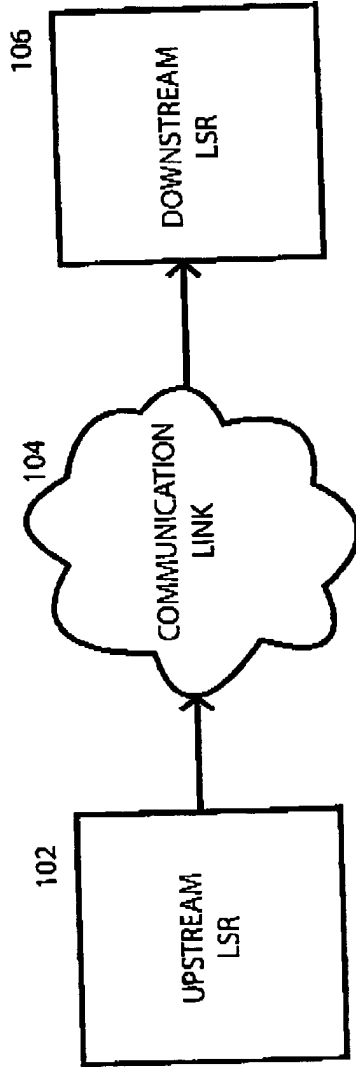
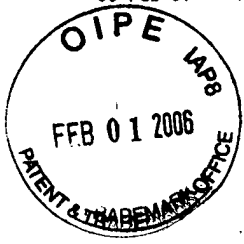

Figure 1 100

Serial No. 09/618530; docket 120-183
Andersson et al.
... Faxed: 2/1/2006

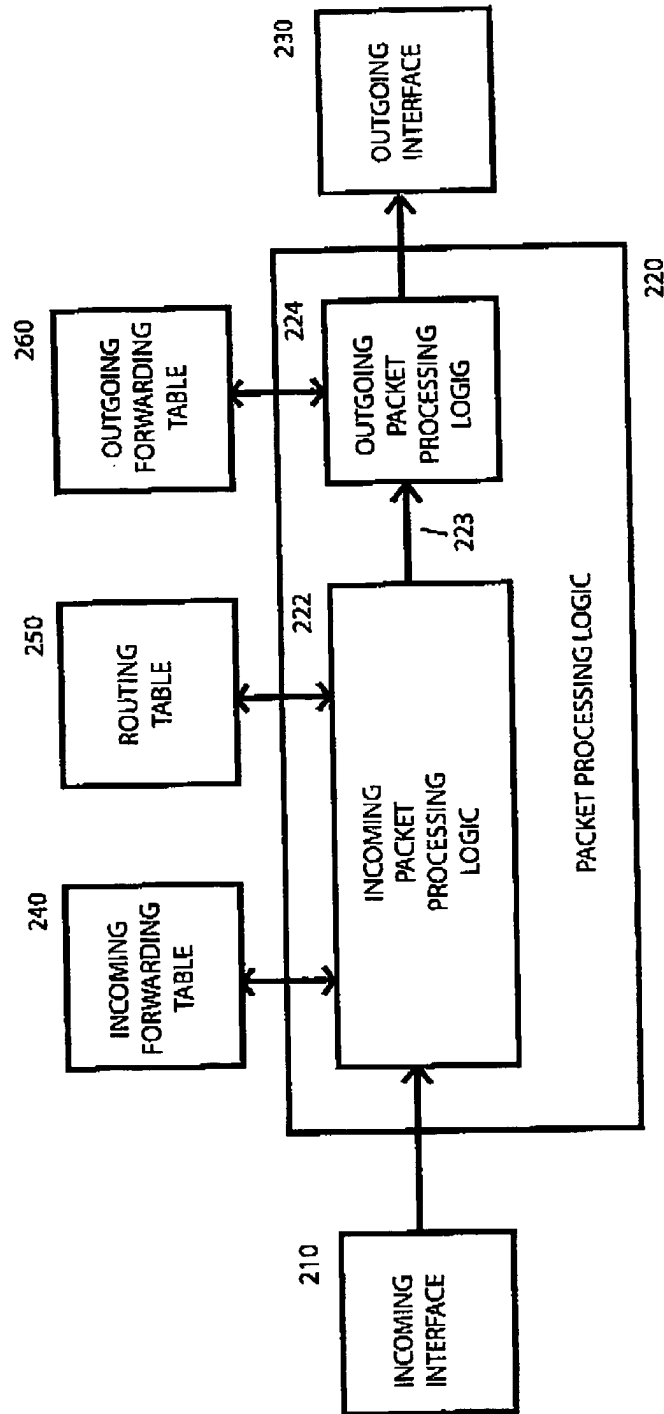

Figure 2 102,106

Serial No. 09/618530; docket 120-183
Andersson et al.
... Faxed: 2/1/2006

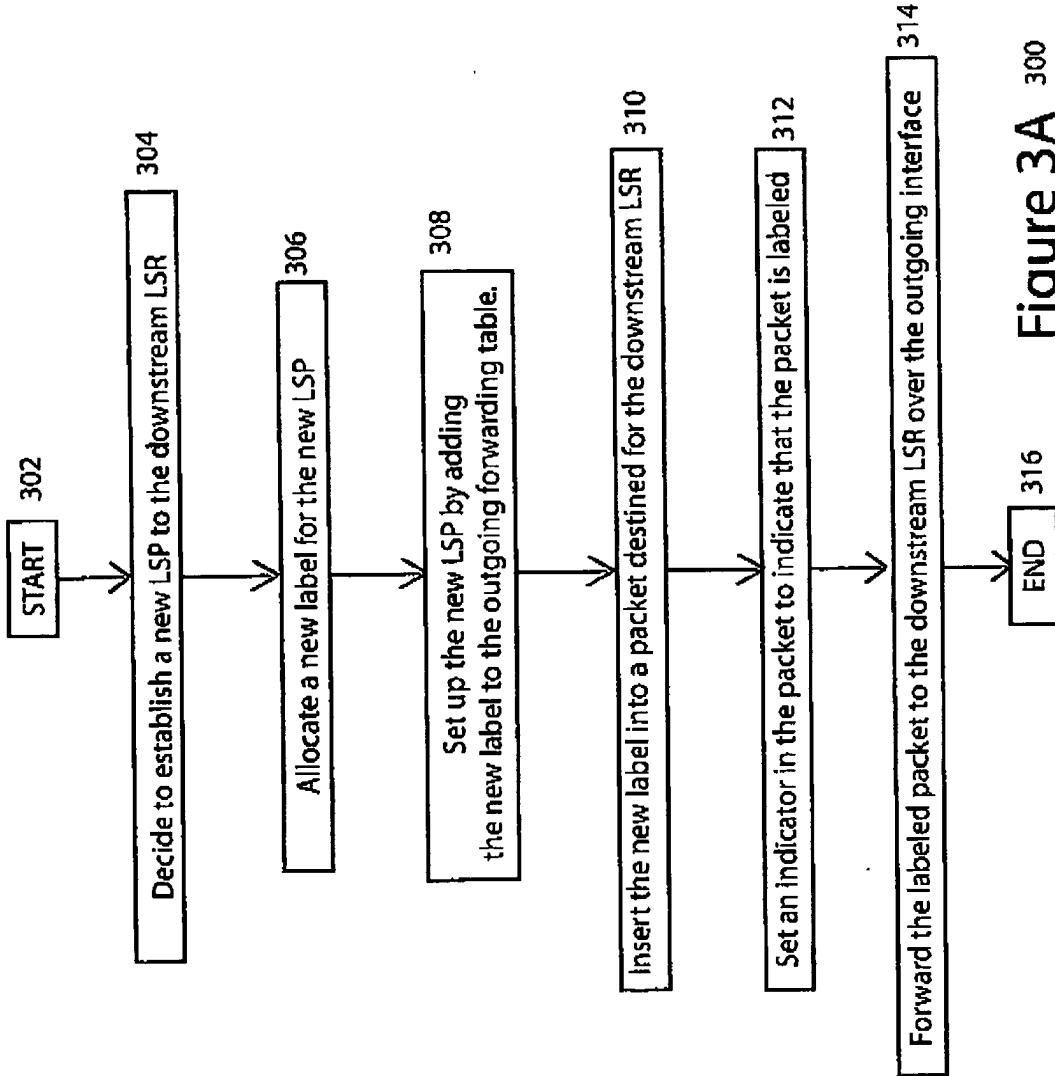

Figure 3A 300

Serial No. 09/618530; docket 120-183
Andersson et al.
... Faxed: 2/1/2006

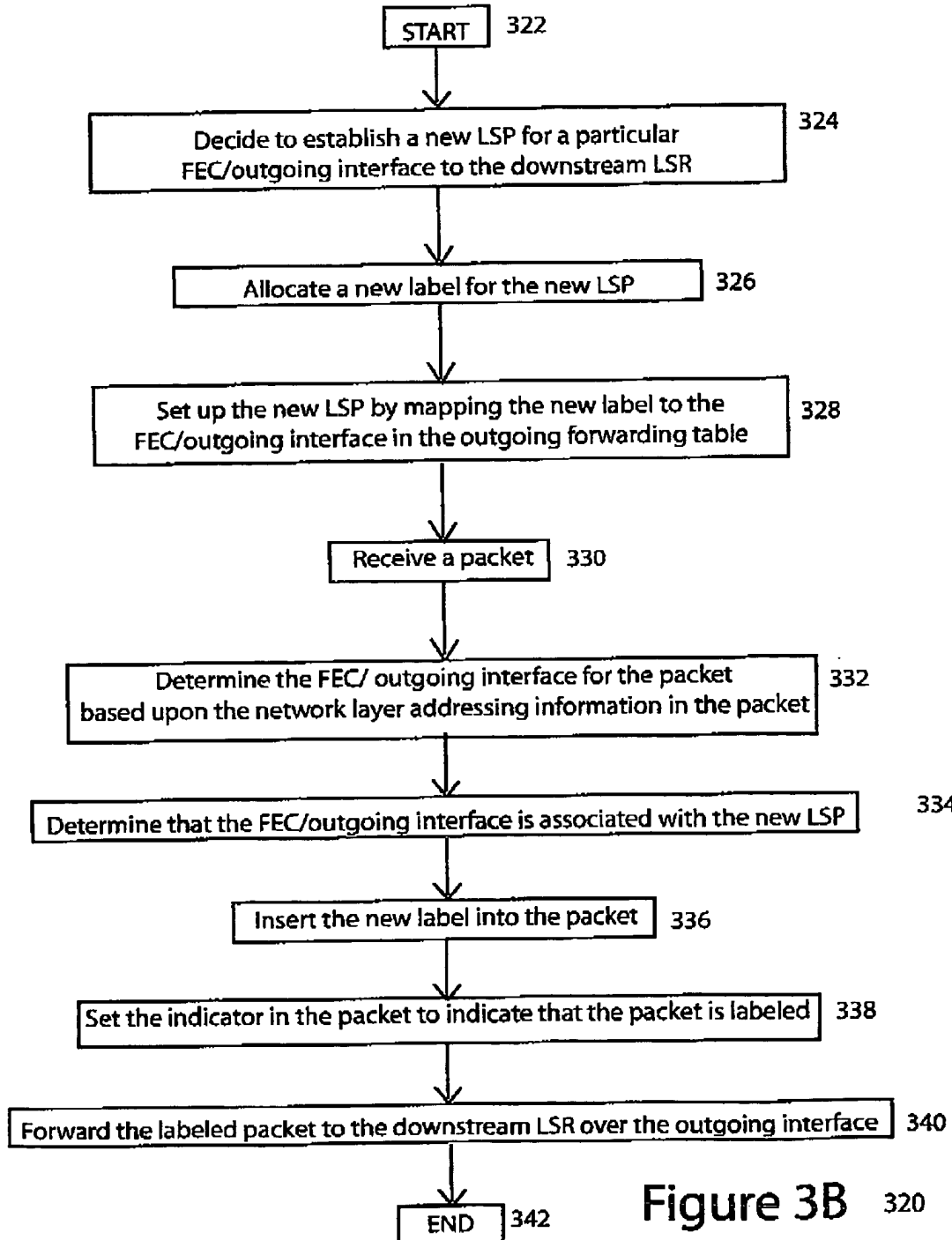

Figure 3B 320

Serial No. 09/618530; docket 120-183

Andersson et al.

... Faxed: 2/1/2006

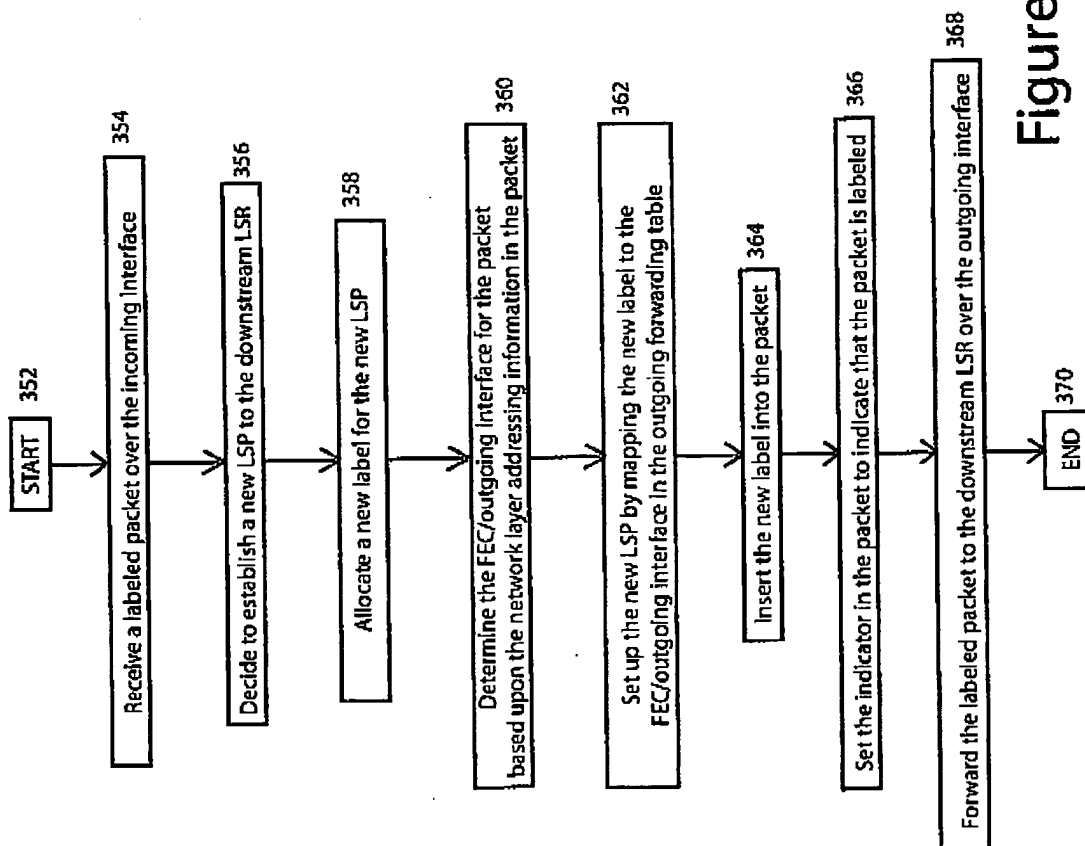

Figure 3C 350

Serial No. 09/618530; docket 120-183
Andersson et al.
... Faxed: 2/1/2006

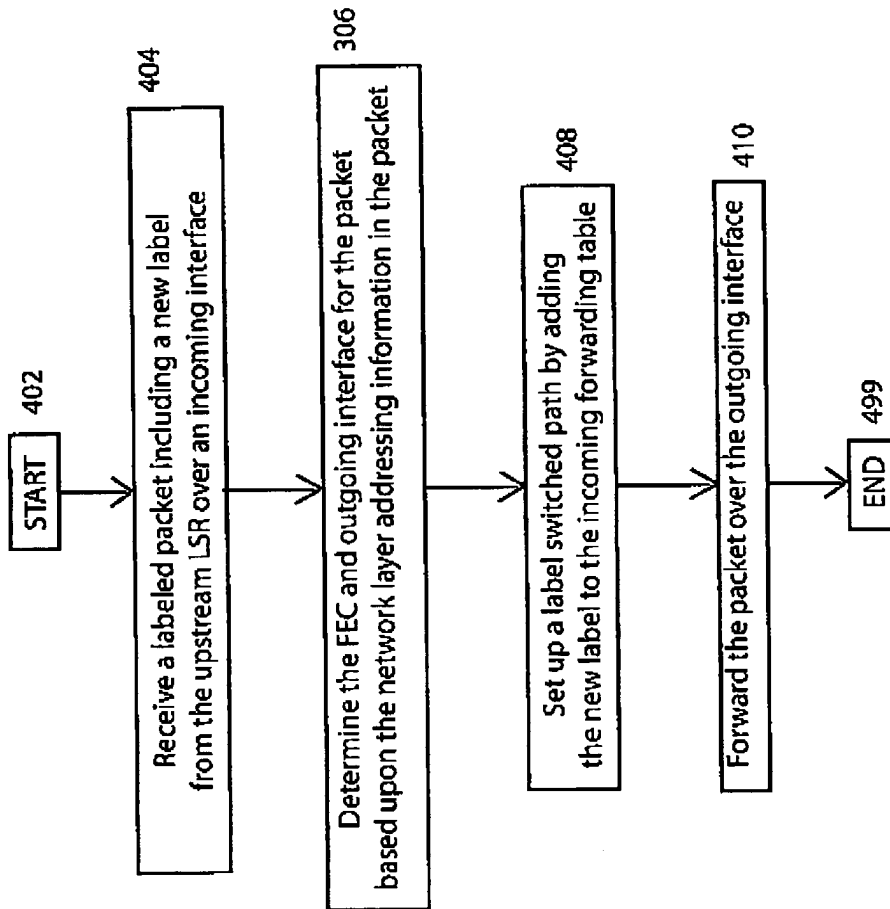

Figure 4 400

Serial No. 09/618530; docket 120-183
Andersson et al.
... Faxed: 2/1/2006

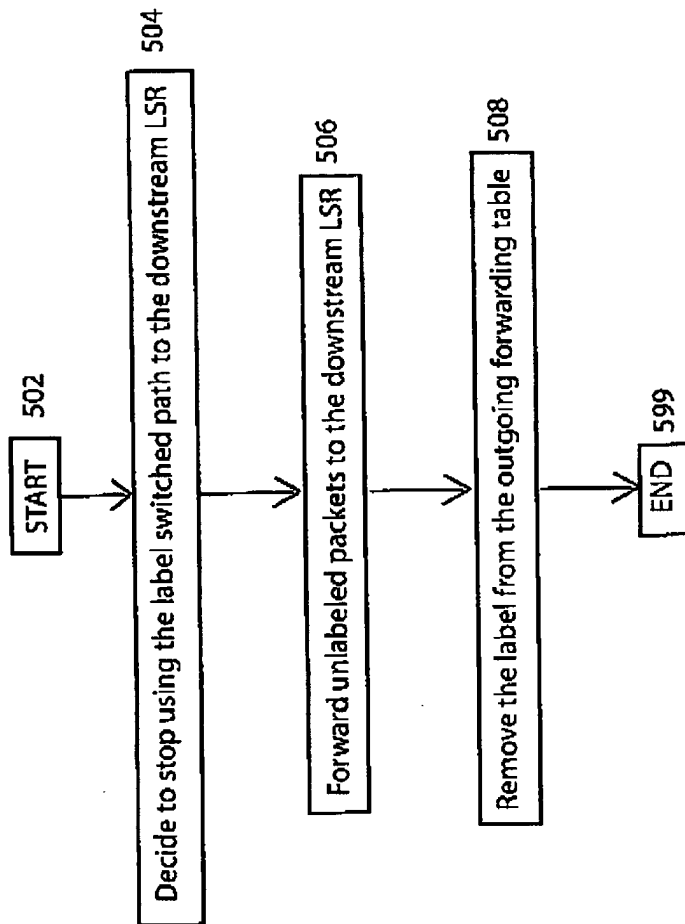

Figure 5 500

Serial No. 09/618530; docket 120-183
Andersson et al.
... Faxed: 2/1/2006

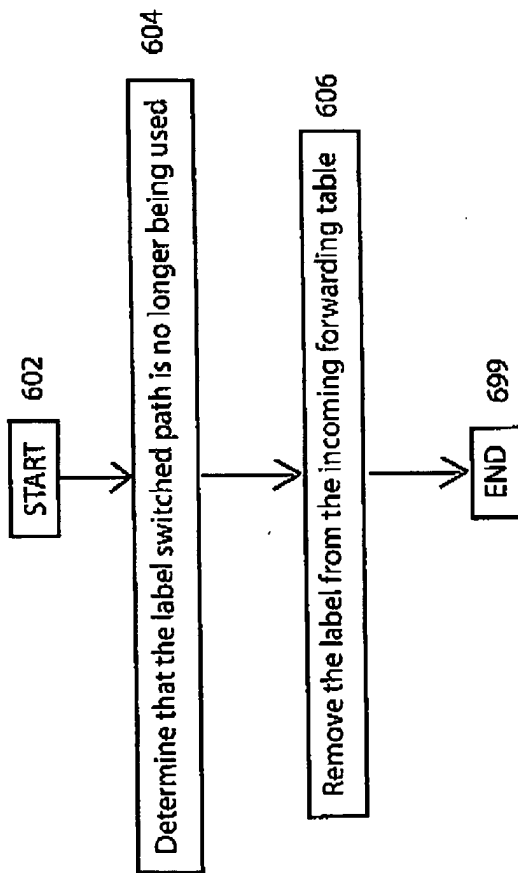

Figure 6 600

Serial No. 09/618530; docket 120-183
Andersson et al.
... Faxed: 2/1/2006

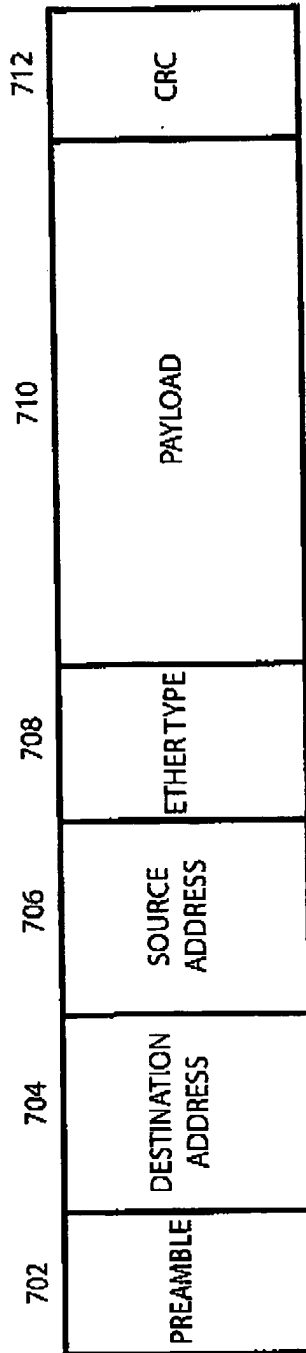

Figure 7 700

Serial No. 09/618530; docket 120-183
Andersson et al.
Filed: 2/1/2006

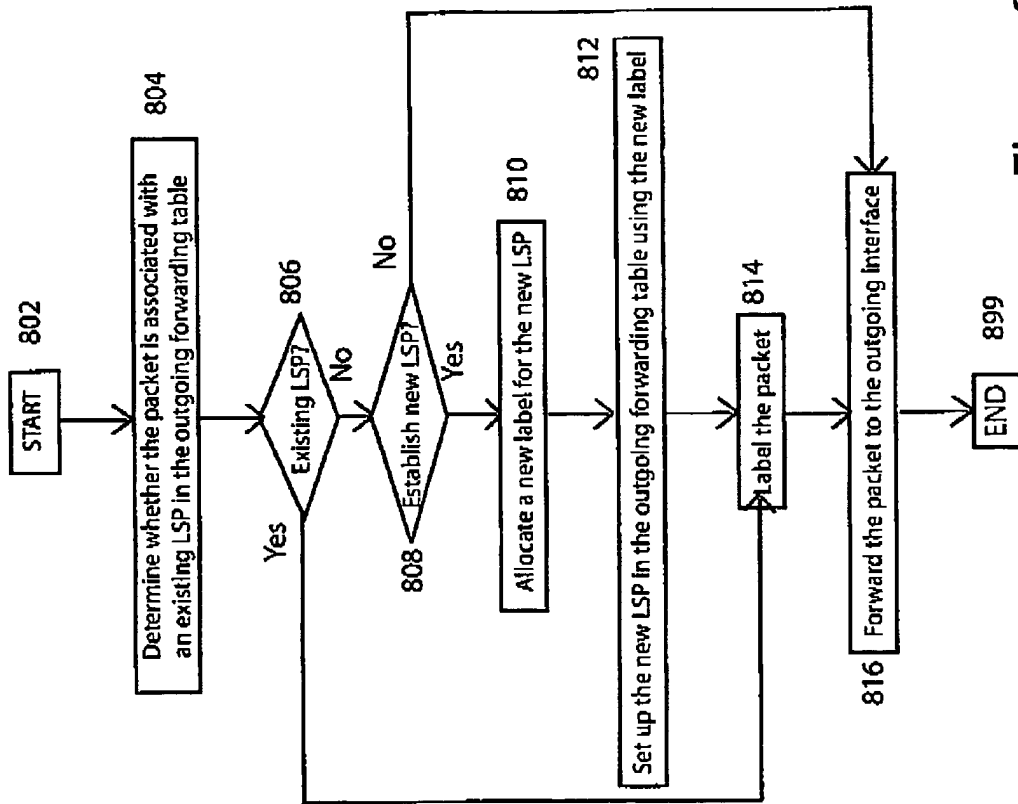

Figure 8 800

Serial No. 09/618530; docket 120-183
Andersson et al.
.. Faxed: 2/1/2006

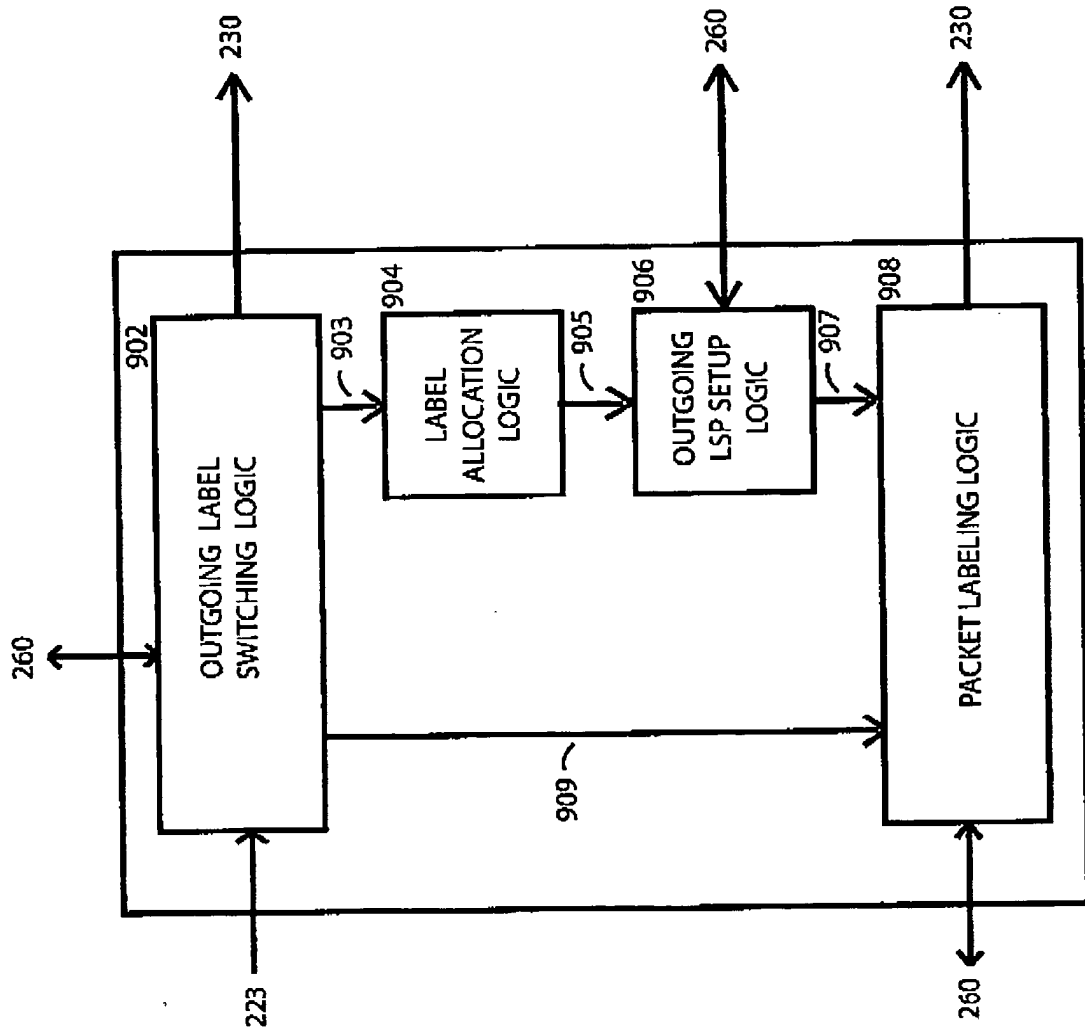

Figure 9 226

Serial No. 09/618530; docket 120-183
Andersson et al.
.. Faxed: 2/1/2006

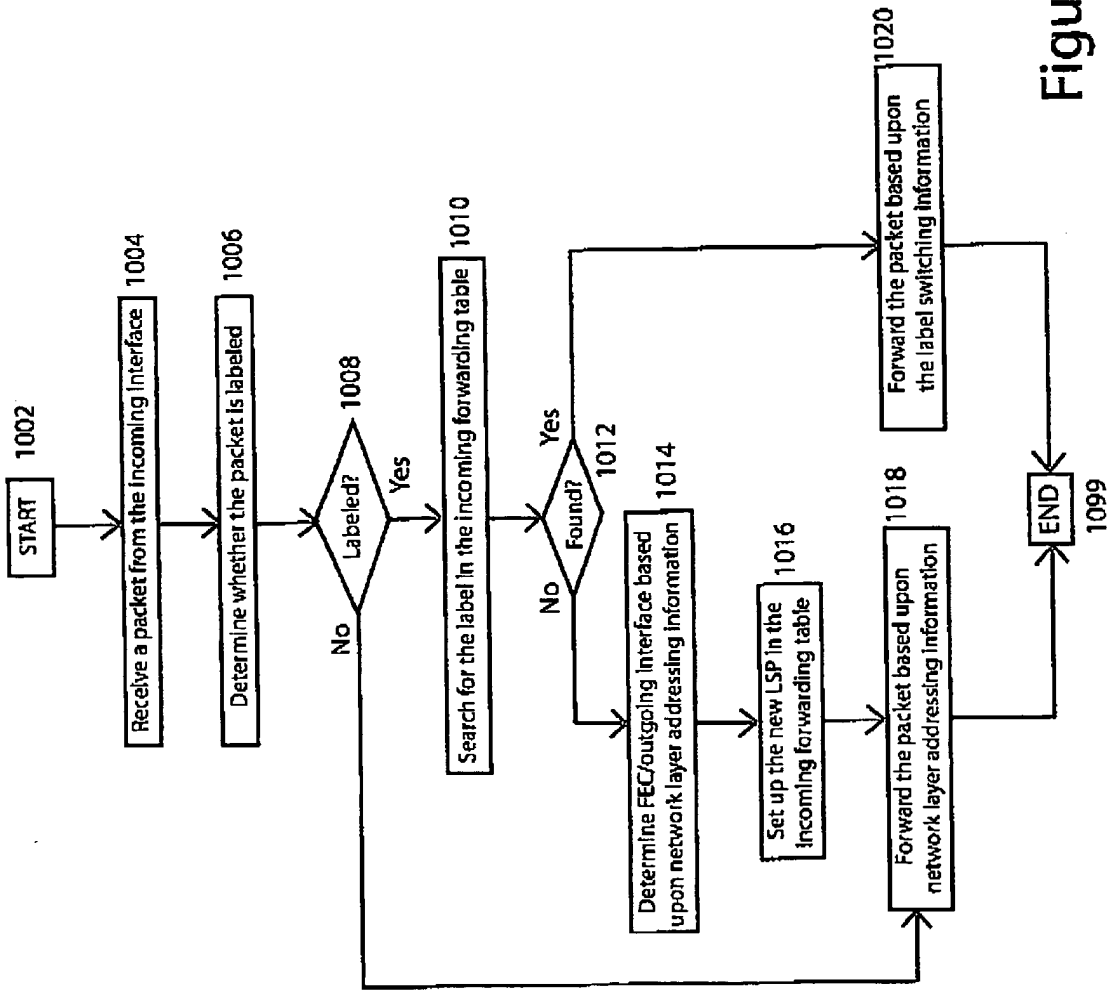

Figure 10 1000

Serial No. 09/618530; docket 120-183
Andersson et al.
Faxed: 2/1/2006

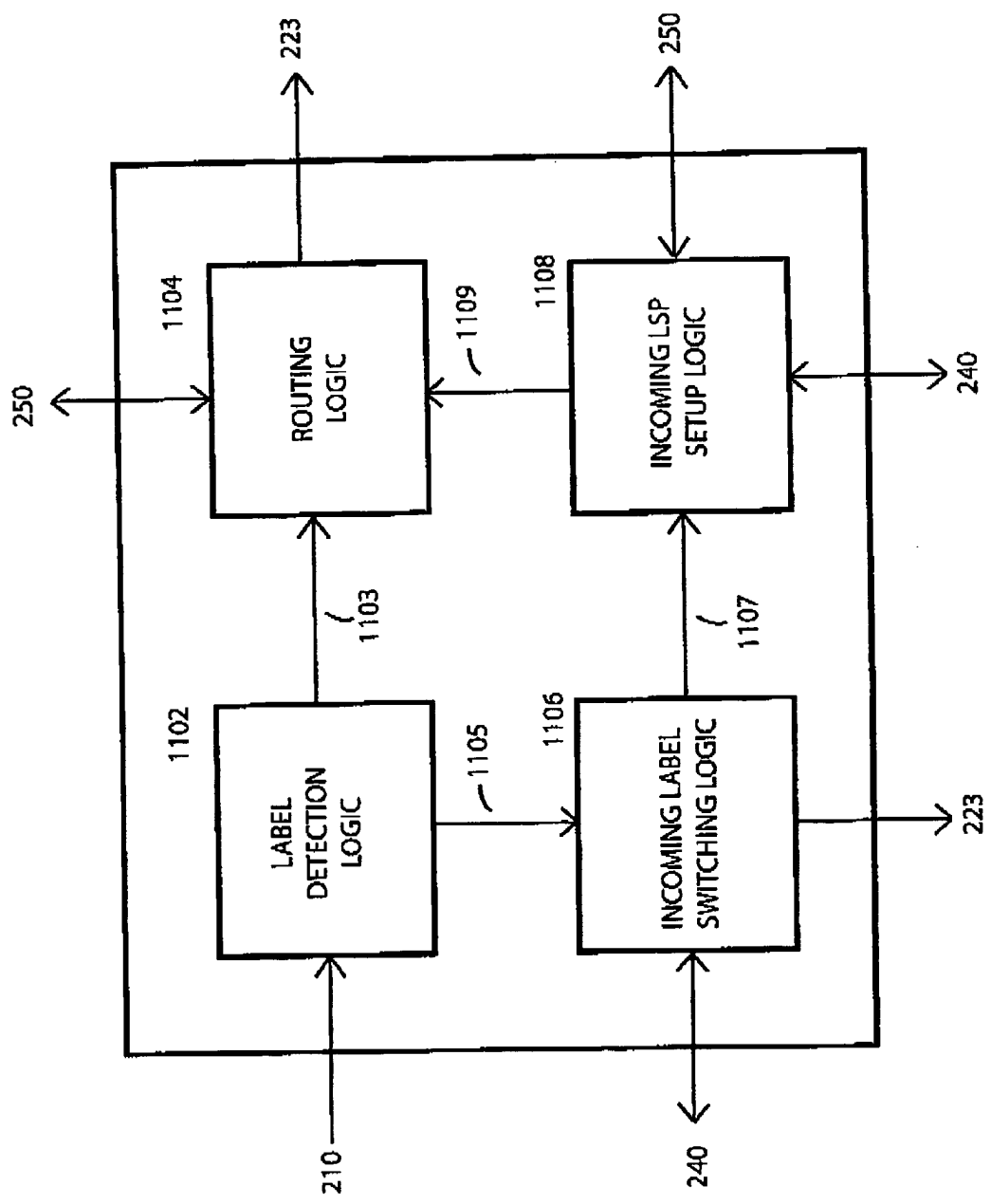

Figure 11 222